



	<p>1 GEAR MOTOR</p> <p>Gear motor Compact-Pro 10 REF. 90757 567,41 Gear motor Compact-Pro 15 REF. 12081 727,63 Gear motor Compact-Pro 20 REF. 12059 1 134,84 Gear motor Compact-Pro 30 REF. 10895 1 172,46 Gear motor Compact-Pro 40 REF. 12033 1 209,85</p>
	<p>TRANSMISSION SHAFT</p> <p>Transmission shaft for EUROPRO Compact-Pro 20, 30 & 40 REF. 11336 120,78</p>
	<p>SHAFT KEY</p> <p>Shaft key 6 x 6 x 40 with round end for Compact-Pro 20, 30 & 40 REF. 11999 3,16</p>
	<p>CONNECTING ROD</p> <p>Connecting rod for EUROPRO Compact-Pro 20, 30 & 40 REF. 11357 204,39</p>
	<p>COMPLETE TRANSMISSION SHAFT</p> <p>Complete transmission shaft for Compact-Pro 10 & 15 REF. 30488 207,04</p>
	<p>2 ROTOR/STATOR KITS</p> <p>Rotor/Stator kit for Compact-Pro 10-15 REF. 30479 234,68 *Rotor/Stator kit for Compact-Pro 20, 30 & 40 REF. 30446 261,27</p>
	<p>PINS</p> <p>Pin screw rotor REF. 90520 7,84 Pin screw transmission shaft REF. 11359 8,53</p>
	<p>3 LUBRICATOR</p> <p>Automatic lubricator REF. 90639 65,17</p>



OIL SEALS

Oil seal for Compact-Pro 10 & 15	REF. 70062.....	7,26
Oil seal for Compact-Pro 20, 30 & 40	REF. 70107.....	11,59



SEALS

4 lobes seal for spacer flange for Compact-Pro 20, 30 & 40	REF. 11337.....	6,77
Seal bottom of hopper for Compact-Pro 20, 30 & 40	REF. 11300.....	12,52



SPACER FOR SEAL

Spacer for seal for Compact-Pro 20, 30 & 40	REF. 11335.....	32,60
---	-----------------	-------

4



MOUNTING BRACKETS

Mounting bracket for Compact-Pro 10 & 15	REF. 10034.....	7,04
Mounting bracket for Compact-Pro 20, 30 & 40	REF. 60010.....	12,83

5



STATOR OUTLETS

Bride stator pour Compact-Pro 10 & 15.....	REF. 10015.....	108,64
Bride stator Compact-Pro 20, 30 & 40	REF. 90125.....	148,98



FEMALE CAM PLUG

Female cam plug 2" POLYPRO for Compact-Pro 20, 30 & 40	REF. 11397.....	38,40
--	-----------------	-------



THREADED ADAPTOR

Threaded adaptor 2" POLYPRO for Compact-Pro 20, 30 & 40.....	REF. 11396.....	19,38
--	-----------------	-------



VALVE

Drain valve for Compact-Pro 10 & 15.....	REF. 70031.....	26,89
--	-----------------	-------

6



WHEELS

Complete wheel, shaft 400mm Ø25 with ball-bearing for Compact-Pro 10 & 15	REF. 80003.....	67,87
Complete wheel, shaft 410mm Ø25 with ball-bearing for Compact-Pro 20, 30 & 40	REF. 80372.....	106,09

7



CHROMED CLIP

Chromed clip Ø25.....	REF. 90282.....	5,38
-----------------------	-----------------	------

8



ARMS & HANDLE

Rubber handel for arm.....	REF. 90255.....	5,17
Arm for Compact-Pro 10 & 15.....	REF. 11578.....	39,50
Arm for Compact-Pro 20, 30 & 40.....	REF. 11380.....	42,56
Round tip tube Ø25 black.....	REF. 90870.....	1,24



ASSEMBLY SPRAY CAN

Assembly spray can stator-rotor	REF. 90640.....	20,00
---------------------------------------	-----------------	-------

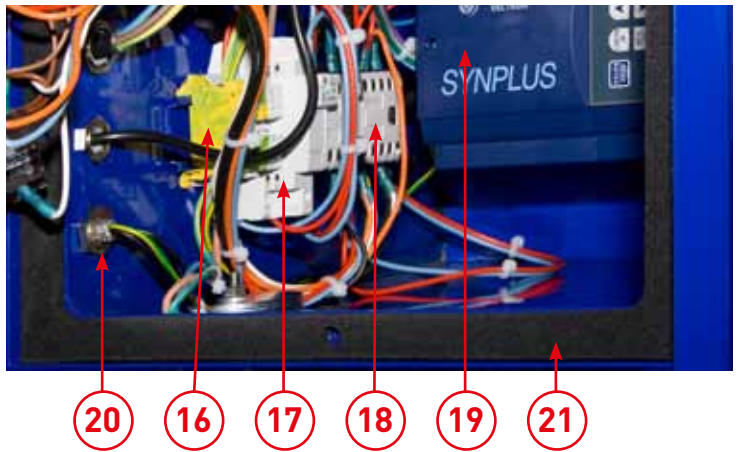
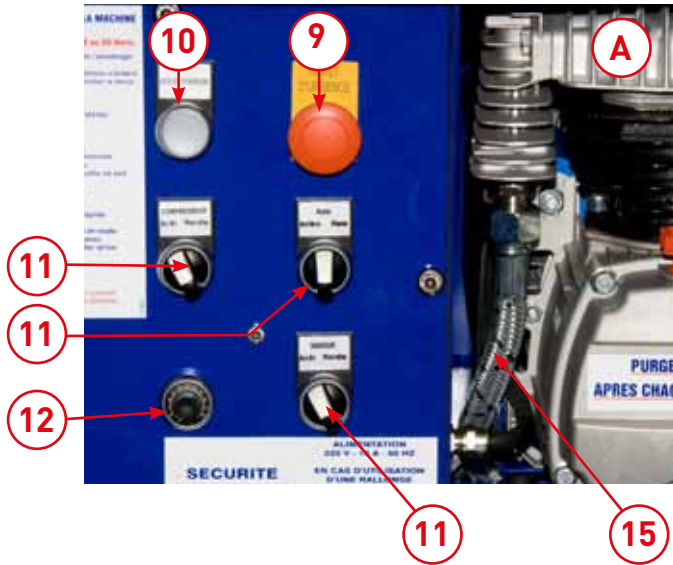

	<p>EMERGENCY STOP BUTTONS</p> <p>* Emergency stop button complete grip 24PT REF. 90778 34,76 * Emergency stop button complete 4P, 6P, 8P, 14P & 24P REF. 90038 32,6932,69 ** Emergency stop push-button complete Ø16 (see picture: B) REF. 13015 34,08</p>
	<p>BUTTON</p> <p>Complete "UNDER VOLTAGE" button 220V REF. 30034 37,87</p>
	<p>BUTTONS</p> <p>Complete REVERSE-AUTO-MANU button REF. 11338 40,51 Complete compressor button "Start-Stop" button REF. 11339 39,31</p>
	<p>POTENTIOMETER</p> <p>Complete potentiometer REF. 80645 54,25</p>
	<p>X</p> <p>Membrane front unit for Compact-Pro REF. 13006 47,04</p>
	<p>ELECTRONIC CONTROL CARD EUROPRO</p> <p>Electronic control card for Compact-Pro REF. 30672 203,25</p>

14



MANOMETER

Axial manometer 1/8" - 50 mm from 0 to 12 REF. 80028 16,15



ELECTRIC CABLE

Power cable with molded plug 3G x 2,5 mm² REF. 90214 42,33



THREADED FEMALE QUICK CONNECTOR

Threaded female quick connector 3/8" REF. 70034 20,04



TAPPED FEMALE QUICK CONNECTOR

Taped female quick connector 3/8" REF. 70035 22,14



LOW PRESSURE BEND

Low pressure bend 90° 1/4" Male C x 1/4" Female S REF. 30121 4,16
 Low pressure bend 90° 3/8" Male C x 3/8" Female S REF. 30120 6,38
 Low pressure bend 90° 3/8" Female S x 3/8" Female S REF. 70024 8,71

15



FLOW METER AIR HOSES

Flow meter air hose for Compact-Pro 10 & 15 REF. 80171 24,91
 Flow meter air hose for Compact-Pro 30 & 40 REF. 11340 30,73
 Compressor outlet air hose for Compact-Pro 10 & 15 REF. 90487 29,59
 Compressor outlet air hose for Compact-Pro 30 & 40 REF. 11341 38,74



FLOW METER

Flow meter for EUROPRO Compact-Pro REF. 30005 313,50



PISTON & SPRING FLOW METER

Flow meter piston REF. 30081 40,56
 Flow meter spring REF. 10070 14,48



FLOW METER DETECTOR 220 VOLT

Flow meter detector 220 Volt REF. 30354 54,21

16



CONDUCTOR COMPARTMENT

Grey conductor compartment 4mm² REF. 80467 2,30
 Yellow/green conductor compartment 6mm² REF. 30038 5,37

17



FUSE HOLDER

Fuse holder 20A REF. 90183 11,38



FUSE

Fuse 20A REF. 90186 3,15

18



CONTACTOR

Contactor 230 Volt REF. 30011 47,58

19



SPEED VARIATOR

Speed variator for Compact-Pro 10 REF. 11781 338,64
 Speed variator for Compact-Pro 15 & 20 REF. 80458 421,11
 Speed variator for Compact-Pro 30 & 40 REF. 80459 512,86



CABLE GLANDS

Nickel plated cable gland 11 CEN water proof	REF. 30040.....	18,64
Nickel plated cable gland 13	REF. 30332.....	16,48
Nickel plated cable gland M 16	REF. 80445.....	14,23

20



CABLE GLAND NUTS

Cable gland nut 11mm.....	REF. 30060.....	0,79
Cable gland nut 11 mm CEN	REF. 30333.....	6,32
Cable gland nut M16.....	REF. 11327.....	1,06

21

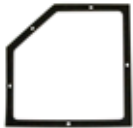

ELECTRIC BOX SEALS

Electric box seal for EUROPRO Compact-Pro 20, 30 & 40	REF. 11361.....	24,59
---	-----------------	-------

AIR / PRODUCT EXTENSION

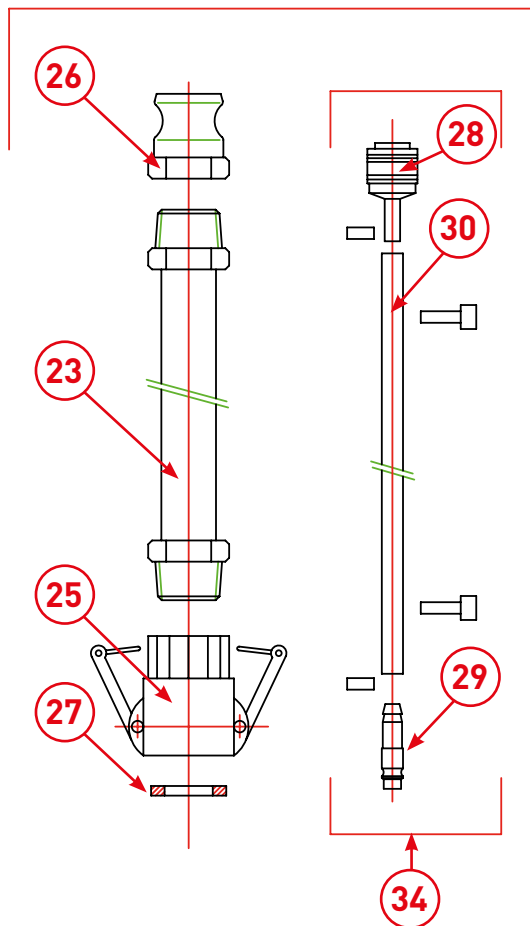

AIR / PRODUCT HOSE

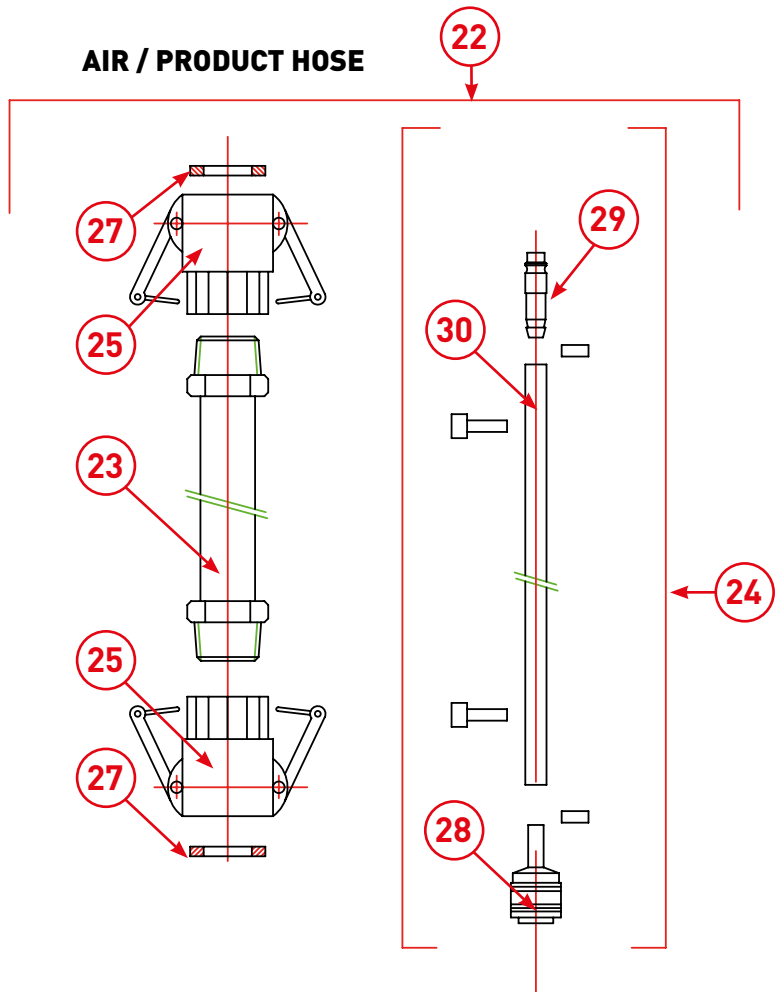

22



COMPLETE AIR / PRODUCT HOSES

Complete air/product hose Ø 25 x 8m for Compact-Pro 10 & 15.....	REF. 50025.....	343,33
Complete air/product hose Ø 25 x 10m for Compact-Pro 10 & 15.....	REF. 50026.....	389,11
Complete air/product hose Ø 25 x 15m for Compact-Pro 15.....	REF. 30144.....	636,72
Complete air/product hose Ø 32 x 10m for Compact-Pro 20 & 30.....	REF. 30143.....	380,79
Complete air/product hose Ø 32 x 15m for Compact-Pro 20 & 30.....	REF. 90542.....	491,07
Complete air/product hose Ø 32 x 20m for Compact-Pro 20 & 30.....	REF. 30144.....	636,72
Complete air/product hose Ø 35 x 10m for Compact-Pro 40.....	REF. 11980.....	401,40
Complete air/product hose Ø 35 x 15m for Compact-Pro 40.....	REF. 11981.....	518,00
Complete air/product hose Ø 35 x 20m for Compact-Pro 40.....	REF. 11982.....	658,85

FOR ALL REQUESTS REGARDING SPECIAL HOSES, PLEASE CONTACT US.

23



PRODUCT HOSES

Threaded product hose Ø 25 x 8m 1" 1/4 x 1" without coupler for Compact-Pro 10 & 15	REF. 50011.....	206,00
Threaded product hose Ø 25 x 10m 1" 1/4 x 1" without coupler for Compact-Pro 10 & 15	REF. 50013.....	246,05
Threaded product hose Ø 25 x 15m 1" 1/4 x 1" without coupler for Compact-Pro 15	REF. 50014.....	337,61
Threaded product hose Ø 32 x 5m 1" 1/4 x 1" without coupler	REF. 91068.....	234,61
Threaded product hose Ø 32 x 10m 1" 1/4 x 1" without coupler	REF. 50015.....	366,22
Threaded product hose Ø 32 x 15m 1" 1/4 x 1" without coupler	REF. 50009.....	497,83
Threaded product hose Ø 35 x 10m 1" 1/4 without coupler	REF. 11977.....	286,25
Threaded product hose Ø 35 x 15m 1" 1/4 without coupler	REF. 11978.....	373,16
Threaded product hose Ø 35 x 20m 1" 1/4 without coupler	REF. 11979.....	502,90

24



COMPLETE AIR HOSES WITH FITTINGS

Complete air hose 8 m for lance for Compact-Pro 10 & 15	REF. 91063.....	52,76
Complete air hose 10m for lance for Compact-Pro 10, 15, 20 & 30	REF. 91065.....	61,47

25



THREADED CAM LOCK CONNECTORS

Threaded cam lock connector 1" for Compact-Pro 10, 15, 20 & 30 lance side	REF. 70007.....	48,41
Threaded cam lock connector 1" 1/4 for Compact-Pro 20, 30 & 40 pump side	REF. 70006.....	60,02

26



THREADED ADAPTOR

Threaded adaptor 1" for Compact-Pro 20 ou 30	REF. 70002.....	17,39
Threaded adaptor 1" 1/4" for Compact-Pro 40	REF. 70012.....	20,90

27



CAM LOCK CONNECTOR SEALS

Cam lock connector seals 1" for Compact-Pro 20 & 30 lance side	REF. 70014.....	5,60
Cam lock connector seals 1" 1/4 for Compact-Pro 20, 30 & 40 pump side	REF. 70015.....	7,26

28



FEMALE QUICK CONNECTOR WITH A FLUTED SHANK

Female quick connector with a fluted shank 9 mm	REF. 70004.....	18,22
---	-----------------	-------

29



MALE QUICK CONNECTOR WITH A FLUTED SHANK

Male quick connector with a fluted shank 9 mm	REF. 70018.....	5,17
---	-----------------	------

30



AIR HOSE PER METER

Armed chrysal air hose per meter Ø10x16	REF. 50003.....	3,02
---	-----------------	------



CAM COUPLERS

Cam coupler 1" for Compact-Pro 20 & 30	REF. 90689.....	16,15
Cam coupler 1" 1/4 for Compact-Pro 20, 30 & 40	REF. 90691.....	19,66



CLEANING BALL

Big cleaning ball for Compact-Pro	REF. 90566.....	6,87
---	-----------------	------



LANCE SEAL KITS

Lance seal kit for spraying machine EUROPRO E.W.I.S.	REF. 80154.....	7,65
Lance seal kit for spraying machine Mortar.....	REF. 80201.....	8,56



LANCE HANDLE

Red handle angled lance	REF. 20003.....	34,13
-------------------------------	-----------------	-------



SPACERS FOR ABS AND ALU LANCES

* Stop spacer	REF. 10030	15,52
** Lance spacer	REF. 10032	3,11



MORTAR LANCE CARRYING CASE

This carrying case contains 1 mortar spray lance for Compact-Pro, 8 spray nozzles (Ø8, 10, 12, 14, 16, 18, 20 & 22 mm), 3 grouting nozzles (Ø10, 12 & 14 mm), 2 cleaning balls, 1 cleaning brush, 1 unplugging pin, 1 Ø7mm Allen key.

Mortar lance carrying case for Compact-Pro	REF. 11833	676,00
--	------------------	--------

Kit with 3 seals for lance conical plug	REF. 80201	8,56
---	------------------	------



MORTAR LANCE

Mortar lance	REF. 11832	571,17
--------------------	------------------	--------



CLAMPING RING

Blue clamping ring	REF. 11817	41,79
--------------------------	------------------	-------



MORTAR NOZZLES

Mortar lance nozzle kit Ø8, 10, 12, 14, 16, 18, 20, 22	REF. 11760	48,22
--	------------------	-------



GROUTING NOZZLES

grouting nozzle kit Ø 10, 12 & 14	REF. 11759	58,94
---	------------------	-------



AIR PLUG MORTAR LANCE

Air plug mortar lance	REF. 11815	9,31
-----------------------------	------------------	------



AIR DRAIN SCREW FOR MORTAR LANCE

Air drain screw for mortar lance	REF. 11805	15,98
--	------------------	-------



AIR FLOW ADJUSTMENT SCREW MORTAR LANCE

Air flow adjustment screw for mortar lance	REF. 11807	13,26
--	------------------	-------



AIR INJECTOR TUBE MORTAR LANCE

Air injector tube for mortar lance	REF. 11814	12,73
--	------------------	-------



ALUMINIUM NOZZLE FOR MORTAR LANCE

Aluminium nozzle for mortar lance	REF. 11757	26,79
---	------------------	-------



TOP BLOCKING SCREW FOR MORTAR LANCE

Top blocking screw for mortar lance	REF. 11804	11,33
---	------------------	-------







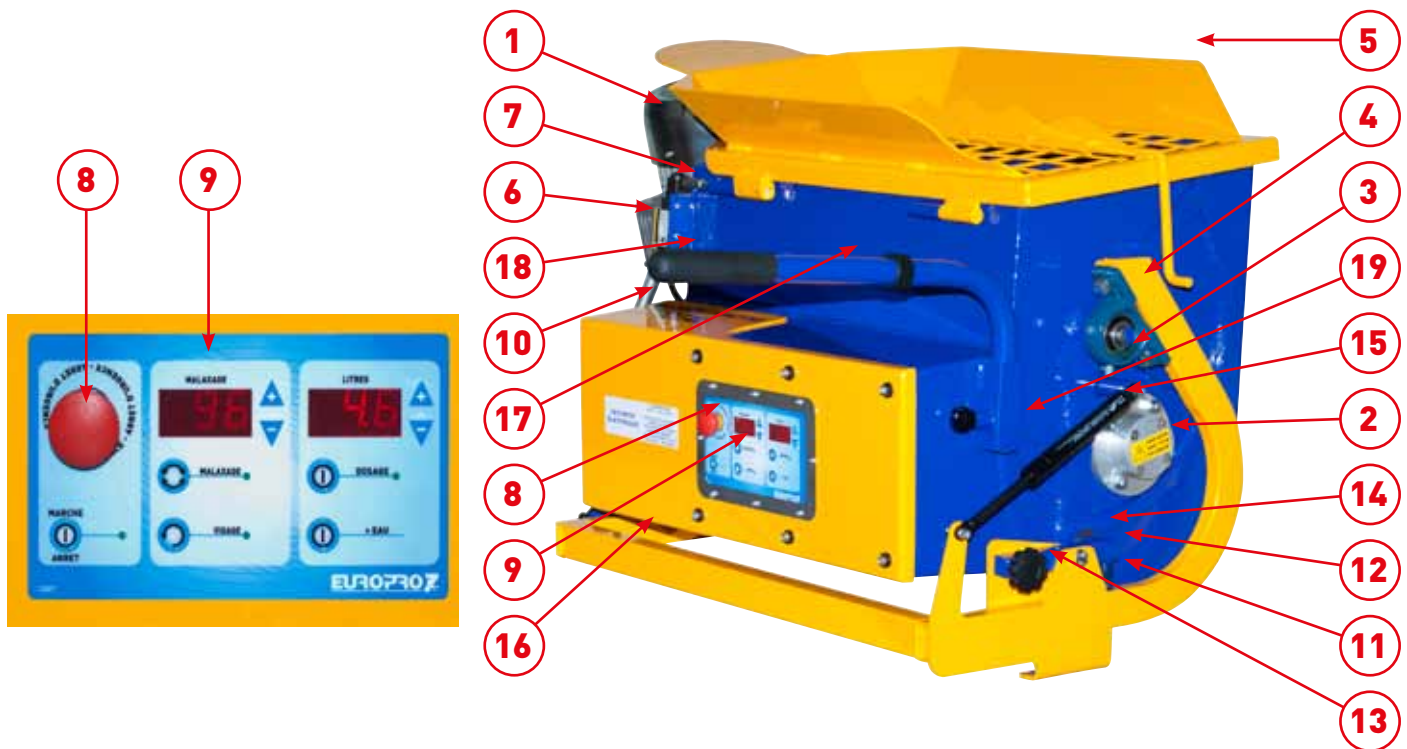





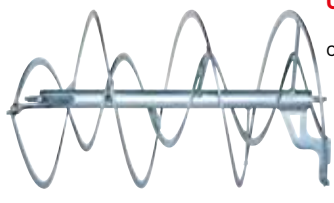











BOTTOM BLOCKING SCREW FOR MORTAR LANCE

Bottom blocking screw for mortar lance	REF. 11806	11,33
--	------------------	-------



<p>1</p> 	<p>ELECTRIC ENGINE MIXER COMPACT-PRO</p> <p>Electric engine mixer Compact-Pro REF. 30043 263,22</p>
	<p>SPEED REDUCER MIXER COMPACT-PRO</p> <p>Speed reducer mixer Compact-Pro REF. 11513 413,39</p>
	<p>REDUCER COVER</p> <p>Reducer plastic cover for 14P2 & 24P REF. 90287 24,21</p>
	<p>TRANSMISSION SHAFT AND KEY SHAFT</p> <p>Transmission shaft for mixer REF. M10063 75,75</p> <p>Key shaft with round ending REF. 90750 6,19</p>
	<p>OIL SEAL</p> <p>Oil seal 50 x 80 x 8 REF. 70107 11,59</p>
	<p>COMPACT-PRO MIXER TRANSMISSION SEAL</p> <p>Compact-Pro mixer transmission seal REF. 12042 10,45</p>
<p>2</p> 	<p>COMPLETE TRANSMISSION SHAFT BEARING FOR MIXER</p> <p>Complete transmission shaft bearing for Compact-Pro mixer REF. M07013 209,89</p>

3		<p>GREASE CHAMBER M6 LUBRAFICATOR</p> <p>Grease chamber M6 lubricator REF. 60012..... 1,45</p>
4		<p>BEARING FOR COMPACT-PRO MIXER</p> <p>Bearing for Compact-Pro mixer REF. 11502..... 32,25</p>
<p>COMPACT PRO MIXER PROPELLER</p> <p>compact-pro mixer propeller REF. 12256..... 283,18</p> 		
5		<p>COMPACT PRO MIXER GRID</p> <p>Compact-Pro mixer grid..... REF. 11488..... 138,36</p>
6		<p>COMPACT-PRO MIXER SECURITY CONTACTS</p> <p>* Compact-Pro mixer security contact - version 1..... REF. 11496..... 65,56</p> <p>** Compact-Pro mixer security contact - version 2..... REF. 12742..... 58,74</p>
7		<p>AXE WITH HINGES FOR MIXER GRID</p> <p>Axe with hinges for mixer grid..... REF. 11500..... 12,32</p>
<p>COMPACT-PRO MIXER CARD BOX SEAL</p> <p>Compact-pro mixer card box seal REF. 12844..... 22,34</p> 		
8		<p>COMPLETE EMERGENCY STOP PUSH BUTTON</p> <p>Complete emergency stop push button Ø16 REF. 13015..... 34,08</p>
9		<p>MIXER MEMBRANE FRONT UNIT</p> <p>Compact-pro mixer membrane front unit REF. 13007..... 47,04</p>
<p>ELECTRONIC CONTROL CARD EUROPRO</p> <p>Compact-Pro mixer electronic control card REF. 30673..... 203,25</p> 		

	<p>CONDUCTOR COMPARTMENT</p> <p>Yellow-green conductor compartment 6mm² REF. 30038 9,41</p>
	<p>FUSE HOLDER</p> <p>Fuse holder 16A REF. 90182 11,38</p>
	<p>FUSE</p> <p>Fuse 16A REF. 90184 2,95</p>
	<p>CONTACTOR 24 V</p> <p>Contactor 24 Volt AC REF. 11918 56,80</p>
	<p>SPEED VARIATOR</p> <p>Speed variator 0,75kW REF. 11781 338,64</p>
	<p>CABLE GLANDS FOR SUPPLY CABLES (BRASS PLATED)</p> <p>Cable glands for supply cables (brass plated) 11 mm REF. 80450 14,83</p>
	<p>ELECTRIC CABLE</p> <p>Supply cable with molded plug 3G x 1,5mm² for E27, E30, E36 REF. 90180 32,29</p>
	<p>THREADED QUICK CLIP BRASS HIGH PRESSURE</p> <p>Threaded quick clip brass High pressure 3/4" REF. 80124 3,62</p>
	<p>FILTER FOR QUICK CLIP BRASS</p> <p>Filter for quick clip brass 3/4" REF. 80128 2,64</p>
	<p>COMPACT-PRO MIXER COPPER HOSE</p> <p>Compact-Pro mixer copper hose REF. C20583 38,45</p>
	<p>COMPACT-PRO MIXER WATER HOSE</p> <p>Compact-pro mixer water hose REF. 12642 28,70</p>
	<p>PLASTIC SEAL</p> <p>Plastic seal Ø20 (3/4") REF. 11618 1,16</p>
	<p>WATER PRESSURE REGULATOR</p> <p>Water pressure regulator from 0,8 to 2,5 bar REF. 12066 33,44</p>

10



FLOW METER SOLENOID VALVE

Compact-Pro mixer flow meter solenoid valve REF. 12341 90,03

11



COMPACT-PRO MIXER PEBBLE SPRING

Compact-pro mixer pebble spring REF. 11495 8,04

12



COMPACT-PRO MIXER PEBBLE SUPPORT

Compact-Pro mixer pebble support REF. 11530 57,23

13



LATCH BUTTON

Plastic button M6 REF. 11515 6,96



ARM LATCH

Compact-Pro mixer arm latch REF. 90179 11,80



COMPACT-PRO MIXER LATCH SPRING

Compact-Pro mixer latch spring REF. 60040 9,94

14



COMPACT-PRO MIXER BEARING

Compact-Pro mixer bearing 6002 REF. 010323 8,95

15



GAS SPRING

Compact-Pro mixer gas spring REF. 11497 63,22

16



FIXATION SUPPORT FOR COMPACT-PRO MIXER

Fixation support for Compact-Pro mixer REF. 11484 20,90



COMPACT-PRO MIXER FIXATION SCREW

Compact-Pro mixer fixation screw M8X20 REF. 11514 6,32

17

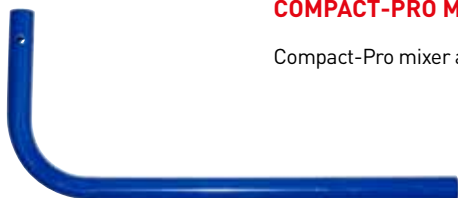

COMPACT-PRO MIXER ARM

Compact-Pro mixer arm REF. 11507 30,69

18



ARM RUBBER HANDLE

Compact-Pro mixer arm rubber handle REF. 90255 5,17

19



ARM PIN

Compact-pro mixer arm pin REF. 90571 11,17

COMPACT-PRO 60



ENGINE



LOMBARDINI diesel thermal engine FOCS LDW 1003 27 CV REF. 91197.....

DRYCOOLER



Hydraulic oil radiator REF. 12308.....

DRYCOOLER PLUG



Plug M22 oil radiator REF. 12638.....

steel seal for plug M22..... REF. 12639.....

RADIATOR BRACE



Radiator brace REF. M10274.....

DEFLECTOR SUPPORT



Oil radiator deflector support REF. C20359.....

AIR CYCLONE



Air aspiration cyclone..... REF. 30811.....



HOSES

- Hose Ø60 Cyclone - Air filter (sold per meter) REF. 12539.....
- hose Ø50 Air Filter - Motor (sold per meter) REF. 12538.....



FOAM FILTER

- Foam filter for Air filter REF. 80335.....



STEEL FILTER CARTRIDGE

- Steel filter cartridge for air filter REF. 30568.....



AIR FILTER SEAL

- Air filter seal REF. 30813.....



BENDED AIR FILTER OUTLET

- Bended air filter outlet REF. C20428.....



COMPRESSOR AIR FILTER HOSE

- Compressor air filter hose REF. 12784.....



HOSE CLAMPS

- 2 wires clamp Ø46x53 REF. 12722.....
- 2 wires clamp Ø56x65 REF. 12723.....



EXHAUST MANIFOLD

- Exhaust manifold REF. 30812.....



EXHAUST TUBE

- Exhaust tube REF. C20362.....

EXHAUST PIPE



Exhaust pipe REF. 30539.....

EXHAUST SEAL



Exhaust seal REF. 30793.....

DIESEL FILTER



Diesel engine filter REF. 80333.....

OIL FILTER



Engine oil filter REF. 80334.....

SOLENOID DIESEL FILTER



Solenoid diesel filter REF. 30769.....

DIESEL PRIMING PUMP



Diesel priming pump REF. 30748.....

PRIMING PUMP SEAL



Priming pump seal REF. 30749.....

ALTERNATOR BELT



Alternator belt REF. 30714.....



COMPRESSOR COMPRESSION HEAD

Compression head REF. 12653.....



COMPRESSOR HEAD BRACKET

Compression head bracket REF. C20860.....



FIXING FITTING

Fixing fitting REF. C20364.....



PULLEY

Aluminium pulley 13mm Ø200 mm REF. 12482.....



TRAPEZOIDAL BELT

Trapezoidal belt 13 x 9 LP 1030 LA 1048 REF. 12478.....



ADMISSION BEND

Compressor air admission bend REF. C20569.....



AIR DEFLECTOR

Compressor air deflector REF. C20813.....

AIR TANK

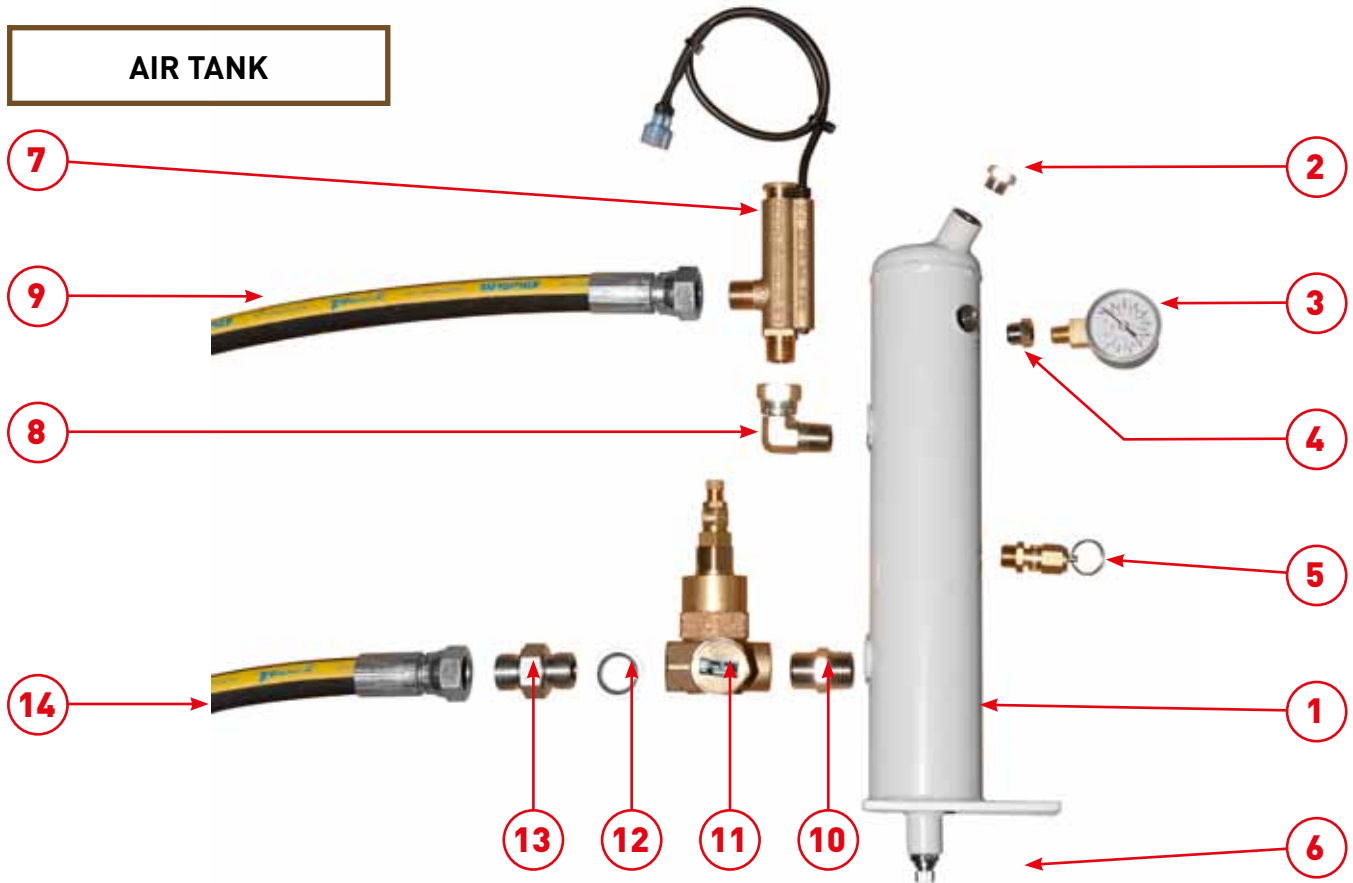

1	AIR TANK Compressor air tank REF. C20897
2	TANK PLUG Tank low pressure plug 1/4 Male REF. 30118
3	MANOMETER Radial manometer 1/8 conical Ø40mm from 0 to 10 bars REF. 80063
4	LOW PRESSURE REDUCER Low pressure reducer 1/4 Male C x 1/8 Female S REF. 90240
5	SECURITY VALVE Approved threaded security valve 1/4 11 bar REF. 80097
6	TANK DRAIN Air tank drain 1/4 REF. 30133
7	FLOW METER Flow meter REF. 30005
8	BEND High pressure bend 3/8 Male C x 3/8 Female S REF. 10878
9	FLOW METER HOSE Hose #213 air tank air outlet REF. 13073
10	LATCH Low pressure latch 1/2 Male C x 1/2 Male C REF. 30369

11

AUTONOMOUS VALVE

Drain autonomous valve 1/2 REF. 80076.....

12

SEAL

Steel seal for empty screw 1/2 REF. 91032.....

13

LATCH

High pressure latch 1/2 Male S x 1/2 Male S REF. 90627.....

14

AUTONOMOUS VALVE HOSE

Hose #212 compressor outlet REF. 13072.....

AIR OUTLET

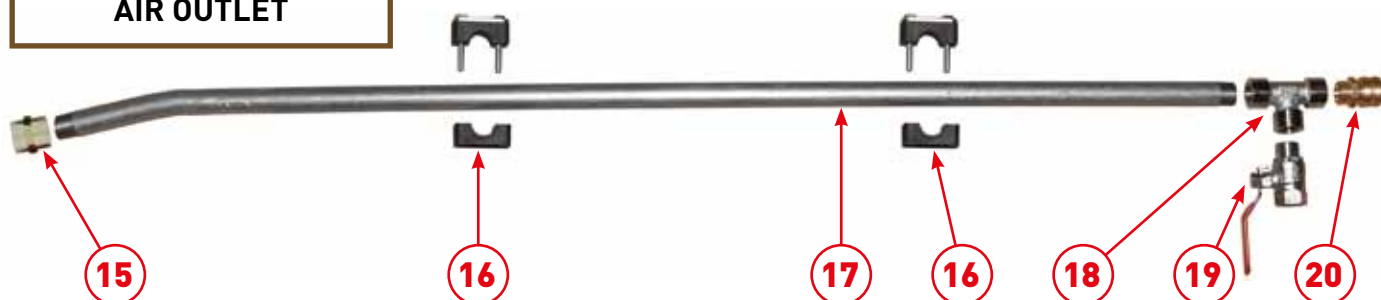

15

LOW PRESSURE LATCH

Low pressure latch 1/2 Female S x 1/2 Female S REF. 90388.....

16

CLAMP

Latch clamp Ø21,3 mm REF. 13150.....

17

1 METER LATCH

Latch 1/2 - length 1 meter REF. 13201.....

18

T

Low pressure T F1/2 x F1/2 x F1/2 REF. 12105.....

19

VALVE

Red handle valve M1/2 x F1/2 REF. 90023.....

20

QUICK CONNECTOR

Threaded female quick connector 1/2 REF. 70036.....



BATTERY

"Maintenance free" battery 12V / 50 AH - 400A REF. 80188.....



BATTERY FIXATION

Battery fixation REF. C20352.....



BATTERY PODS

+ battery pod REF. 80230.....
 -battery pod. REF. 80231.....



BATTERY CABLE

Battery cable 25mm² (sold per meter) REF. 80234.....



BATTERY CABLE POD

Ø8mm Pierced welded pod for battery cable 25mm² REF. 80235.....



CIRCUIT BREAKER

Battery circuit breaker..... REF. 12394.....



CABLE FOR CIRCUIT BREAKER KEY

Circuit breaker key cable..... REF. 13208.....

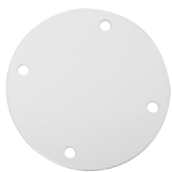

HYDRAULIC TANK LID

Hydraulic tank lid REF. C20659.....



HYDRAULIC TANK LID SEAL

Hydraulic tank lid seal REF. 12780.....



HYDRAULIC TANK VISUAL LEVEL

Hydraulic tank visuel level, entraxe 76mm REF. 12326.....



HYDRAULIC TANK VALVE

Hydraulic tank valve 1" Female x 1" Female REF. 70031.....



HYDRAULIC RETURN COMPLETE FILTER

Hydraulic return complete filter with breather REF. 12327.....

RETURN FILTER CARTRIDGE



Return filter cartridge REF. 12351.....



BREATHER FILTER CARTRIDGE



Breather filter cartridge REF. 12352.....



SUCTION STRAINER

This strainer is situated inside the hydraulic oil tank. Take away the lid of the tank to reach it.



Suction Strainer 1" - 125µm REF. 12328.....

OIL TANK

21 Oil tank - capacity 28 liters REF. C20862.....

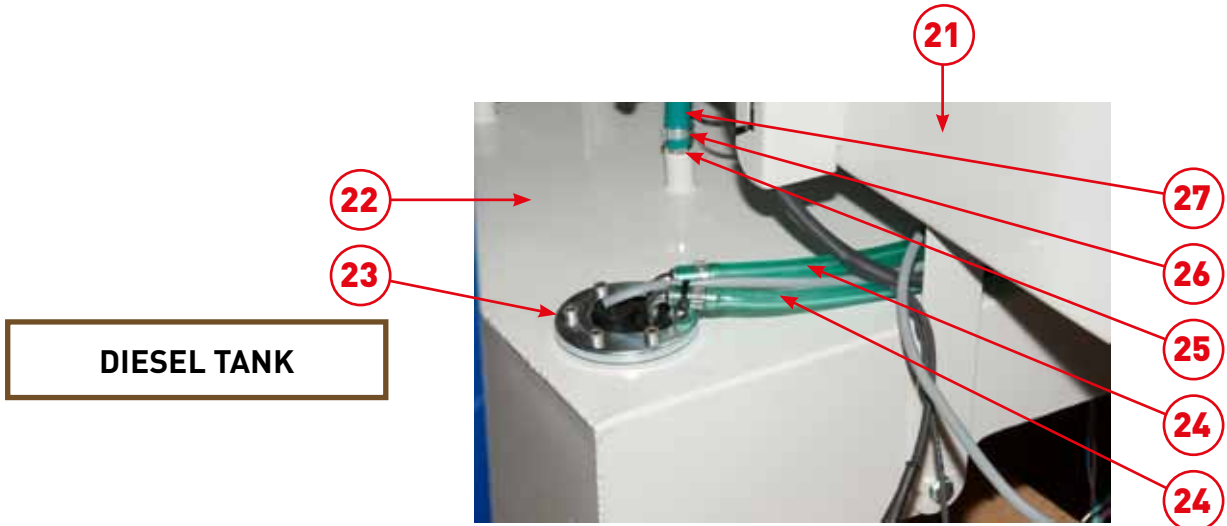

DIESEL TANK

DIESEL TANK

22 Diesel tank - capacity 25 liters REF. C20867.....

DIESEL LEVEL GAUGE



Diesel level gauge - length 250 mm REF. 12989.....

DIESEL HOSES



Diesel hose Ø6mm (sold per meter) REF. 12390.....

Diesel hose Ø7mm (sold per meter) REF. 12391.....

25



CONNECTOR WITH A FLUTED SHANK

Connector with a fluted shank 1/4 - Ø10 REF. 80094.....

26



EAR CLAMPS

Ear clamp Ø9 x 11..... REF. 30411.....
 Ear clamp Ø11 x 13..... REF. 60031.....
 Ear clamp Ø13 x 15..... REF. 60032.....
 Ear clamp Ø15 x 18..... REF. 80429.....

27



BREATHER HOSE

breather hose Ø10 x18 (sold per meter)..... REF. 50021.....



PRE-WIRED CONNECTOR

Diesel gauge pre-wired female connector..... REF. 12750.....



KEY PLUG

Diesel tank key plug..... REF. 13107.....

WATER METER



28



WATER METER

Mechanical water meter from 0 to 50 liters..... REF. 12416.....

Mechanical water meter graduated button..... REF. 12931.....

29



WATER METER SUPPORT

Mechanical water meter support..... REF. C20370.....

30

WATER SUPPLY HOSE



Water supply / water meter / H.P. cleaner pump hose - hose #122 REF. 12621.....

31

REDUCER



Low pressure reducer 3/4 Female S x 1/2 Male S REF. 12526.....

32

H.P. CLEANER OUTLET



80276 10003 90336

Latch HP 3/8 Male S x 3/8 Male C REF. 80276.....
 Spacer large Ø16 REF. 10003.....
 Quick connector Male L M22 - 150 M x 3/8 Female REF. 90336.....

33

WATER CIRCUIT INLET



11891 90012 80128 80124

Latch Low pressure 1/2 Male S x 3/4 Male S REF. 11891.....
 Valve with red handle 3/4 Male x 3/4 Female REF. 90012.....
 Filter for brass quick connector 3/4 REF. 80128.....
 Threaded brass quick connector 3/4 REF. 80124.....

H.P. CLEANER

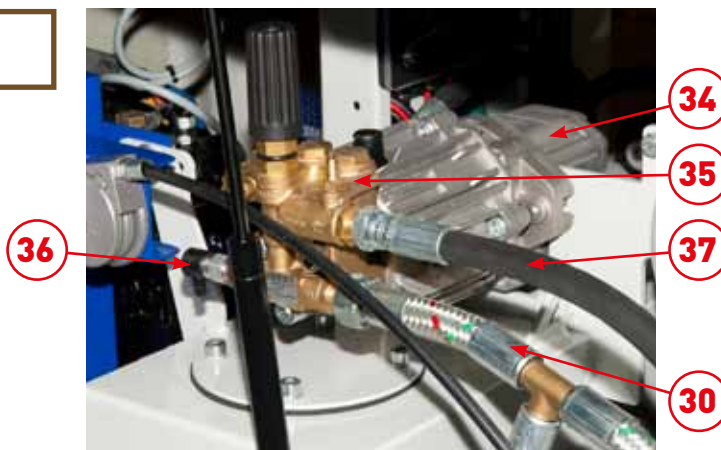

34

CLEANER HYDRAULIC ENGINE



Cleaner unidirectionnal hydraulic engine 6cc REF. 12406.....

35

CLEANER PUMP



11 liters - 140 bars cleaner pump REF. 90352.....

36



THERMOSTATIC VALVE

Thermostatic valve 1/4..... REF. 13101.....

37



H.P. HOSE

Hose #88 - outlet H.P. pump to quick connector REF. 12605.....



HYDRAULIC

50 50 38

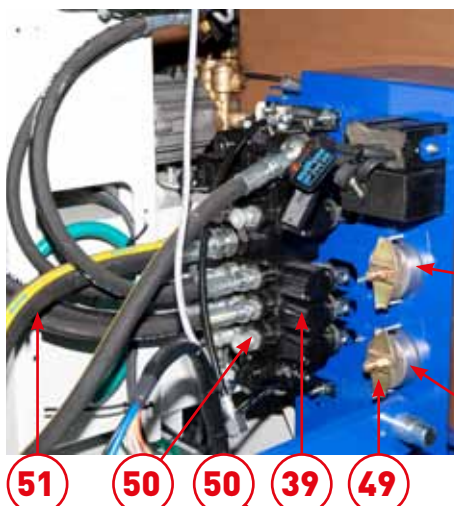

51 50 50 39 49



44 52 51 40 45



51 52 51 41



39 47 48 42 43

38



DOUBLE PUMP

Double pump 14 + 8 cc..... REF. 12405.....

39



HYDRAULIC DISTRIBUTOR

Hydraulic distributor 5 positions with L.P. and hopper By-Pass integrated with handles..... REF. 12332.....

40



HYDRAULIC CYLINDER BLOC

Hydraulic cylinder limiter bloc REF. M10405

41



HYDRAULIC SPEED REGULATOR BLOC

Hydraulic speed regulator bloc REF. M10404

42



MIXER FLOW LIMITER

Cartridge flow limiter 45L/min simple for mixer REF. 13016

Setting handwheel manufactured REF. M10421

43



LIMITEUR DE DÉBIT TRÉMIE

Cartridge flow limiter 20L/min compensated for hopper REF. 13143

Setting handwheel manufactured REF. M10421

44

HYDRAULIC CYLINDER MIXER FLOW LIMITER

Cartridge flow limiter for the rise of the hydraulic cylinder mixer REF. 13144

45

HYDRAULIC CYLINDER MIXER PRESSURE LIMITER

Cartridge pressure limiter for the rise and descent of the hydraulic cylinder mixer REF. 13020

46



BY-PASS VALVE WITH ELECTRIC COIL FOR MIXER

By-pass valve with electric coil for mixer REF. 12912

47



HOPPER MANOMETER

Oil axial manometer 1/4 cylindric Ø63 from 0 to 250 bar REF. 13207

48



MIXER MANOMETER

Oil axial manometer 1/4 cylindric Ø63 from 0 to 160 bar REF. 12342

49



MANOMETER FIXATION BRACKET

Manometer fixation bracket Ø63 REF. 80195

50

MANOMETER HOSE



Manometer hose 400 mm 1/4 Female x 1 banjo DN 14mm REF. 13027.....

51

HIGH PRESSURE LATCHES



High pressure latch 1/4 Male S x 1/4 Male S REF. 90703
 High pressure latch 1/4 Male S x 3/8 Male S REF. 90704
 High pressure latch 3/8 Male S x 3/8 Male S REF. 90698
 High pressure latch 1/2 Male S x 1/2 Male S REF. 90627
 High pressure latch 1/2 Male S x 3/8 Male S REF. 90872
 High pressure latch 1/2 Male S x 3/4 Male S REF. 12733
 High pressure latch 3/4 Male S x 3/4 Male S REF. 90774
 High pressure latch 3/4 Male S x 1" Male S REF. 12569
 High pressure latch 1" Male S x 1" Male S REF. 12568

STEEL SEALS



Steel seal for empty screw 1/4" REF. 91016
 Steel seal for empty screw 3/8" REF. 91031
 Steel seal for empty screw 1/2" REF. 91032
 Steel seal for empty screw 3/4" REF. 12573
 Steel seal for empty screw 1" REF. 12572
 Steel seal for empty screw M14 REF. 13058
 Steel seal for empty screw M22 REF. 13539

SCREW WITH PIERCED HEAD



Screw with pierced head 1/4 REF. 90863
 Screw with pierced head 1/2 REF. 91034

THREADED BANJO



Threaded banjo 1/2 x 1/2 REF. 12571

52

HOSES

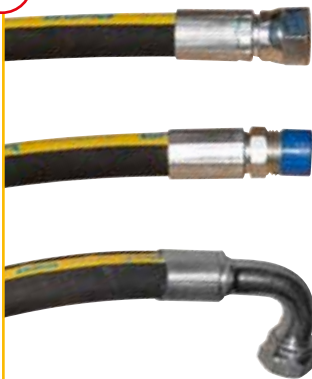

Flexible #42 - hydraulic cylinder supply REF. 12606
 Flexible #50 - drycooler return / hydraulic tank REF. 12619
 Flexible #200 - hydraulic tank return REF. 13059
 Flexible #201 - hopper main controls REF. 13060
 Flexible #202 - cleaner REF. 13061
 Flexible #203 - cleaner REF. 13062
 Flexible #204 - mixer main controls REF. 13063
 Flexible #205 - hydraulic cylinder main controls REF. 13064
 Flexible #206 - valve control REF. 13065
 Flexible #208 - hopper outlet REF. 13068
 Flexible #209 - mixer outlet REF. 13069
 Flexible #210 - distributor / drycooler REF. 13070
 Flexible #211 - hydraulic tank supply REF. 13071
 Flexible #214 - mixer circuit supply REF. 13074
 Flexible #215 - hopper circuit supply REF. 13075
 Flexible #216 - control valve control REF. 13067

DOUBLE CLAMP



Double clamp Ø22 mm REF. 12438

SPIRAL SHEATHS



Spiral sheaths Ø8 REF. 80232
 Spiral sheaths Ø20 REF. 13205
 Spiral sheaths Ø35 REF. 13206

MIXER LIFT CYLINDER

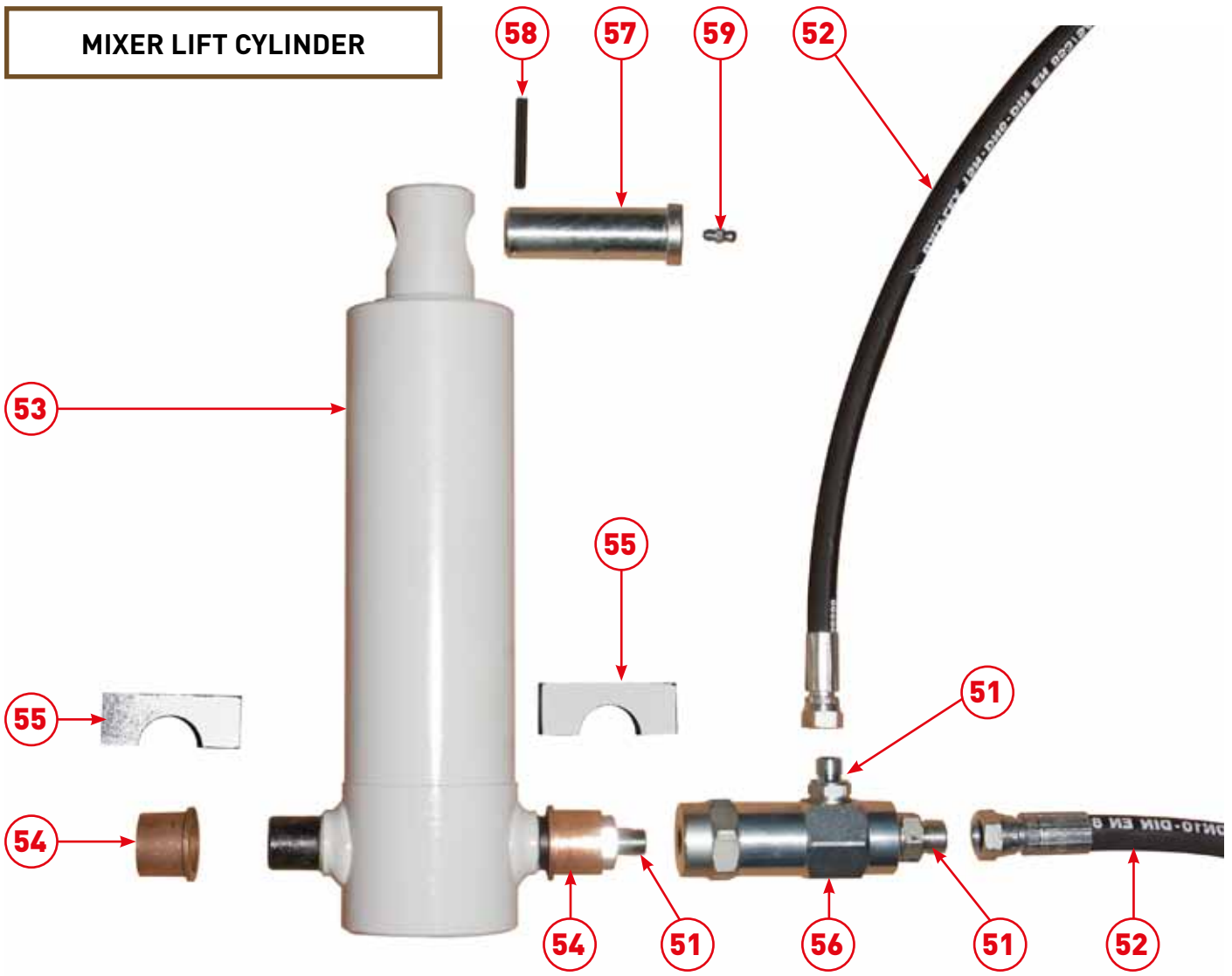

53 **HYDRAULIQUE CYLINDER**
 mixer telescopic hydraulic cylinder REF. 12307

54 **SELF-LUBRICATING BRONZE RING**
 Self-lubricating bronze ring 25 x 30 x 25 mm REF. 12513

55 **HYDRAULIC CYLINDER FLANGE**
 Hydraulic cylinder flange REF. M10260

56 **CHECK VALVE**
 Check valve FG 1/4 REF. 12574

57 **HYDRAULIC CYLINDER AXIS**
 Hydraulic cylinder axis REF. M10251

58 **HYDRAULIC CYLINDER PIN AXIS**
 Hydraulic cylinder elastic pin axis Ø5 x 45 mm REF. 12474

59 **HYDRAULIC CYLINDER AXIS LUBRACATOR**
 Hydraulic cylinder axis lubrator M6 for grease chamber REF. 60012

CHASSIS

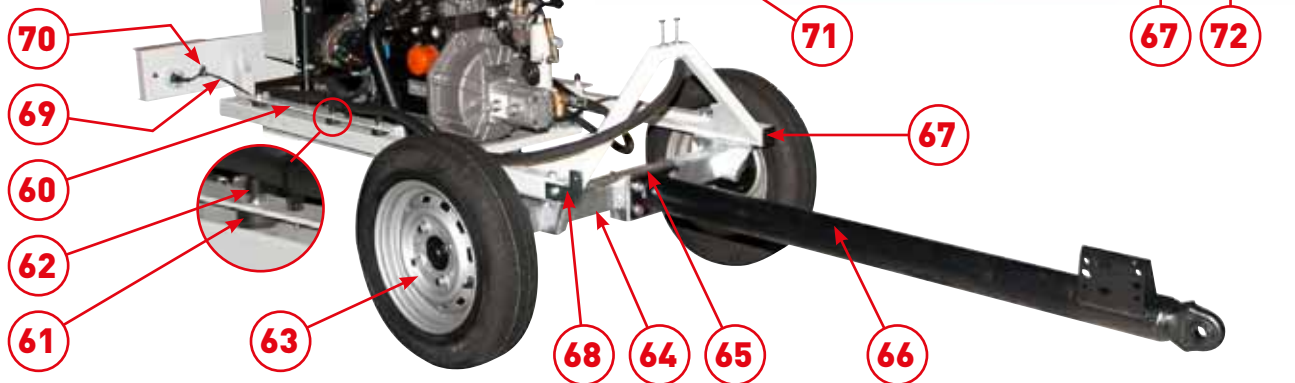

60

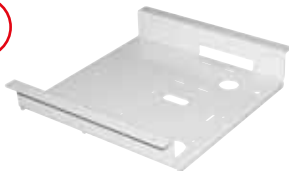

ENGINE PLATINUM

Engine plate REF. C20338

61



SILENTBLOC

Silentbloc Ø40 x 20 M10 REF. 30150

62



PLASTIC SCREW COVER

PLastic screw cover M10 REF. 12794

63



WHEEL

Complete wheel 145/80 R13 REF. 12346

64



AXLES

900 kg axles REF. 12345

65



PLATINUM SPACER

Platinum spacer for tubular arrow fixation REF. C20350

66



TUBULAR ARROW

Tubular arrow 750 kg - length 1400 mm REF. 12348

67



TUBE TIP

Tube plastic tip 50x50 mm REF. 12665

68



FIXATION PLATE IN L

Fixation plate in L for right side fender REF. C20366

69



COMPLETE BEAM

Tail lights complete beam REF. 12801

TRAILER JACK.....



7 pins trailer jack..... REF. 12355

70



WIRE-PASS CLIP

Wire-pass clip Ø10 REF. 12395

71



LEFT TAIL LIGHT

Left tail light..... REF. 12802

72



RIGHT TAIL LIGHT

Right tail light REF. 12803

LEFT FENDER



Left side fender (short) REF. 13093

RIGHT FENDER



Right side fender (long)..... REF. 13094

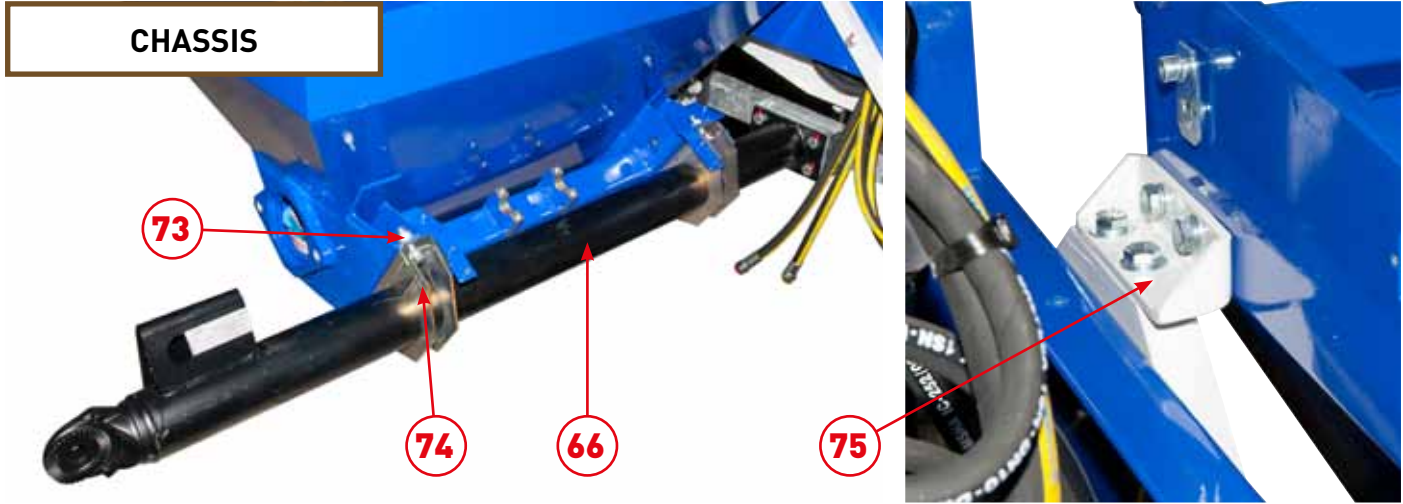

73 **HOPPER FIXING PLATE**

hopper fixing plate. REF. C20395

74 **HOPPER FIXING CLAMP**

Complete hopper fixing clamp. REF. 12349

75 **HOPPER HOLDING BRACKET**

hopper holding bracket REF. C20498



HOPPER ENGINE

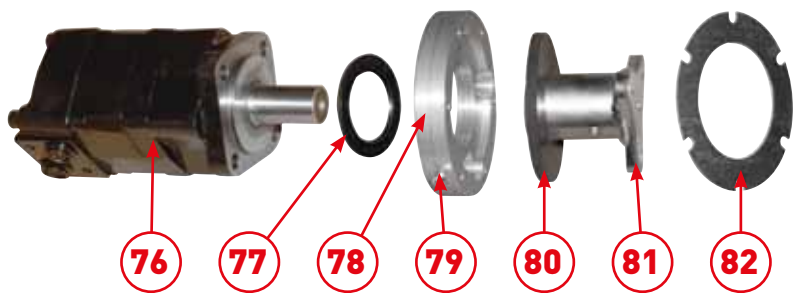

76 **HOPPER HYDRAULIC ENGINE**

Hydraulique orbital engine for hopper BMS 130 REF. 12954

77 **OIL SEAL**

Oil seal 50 x 72 x 6 REF. 12825

78



HOPPER ENGINE BEARING

Hopper engine bearing H25 REF. M10332.....

79



LUBRICATOR

45° x M6 lubricator REF. 12397.....

80



SEAL

bottom of hopper seal REF. 12511.....

81



ENGINE / HOPPER COUPLING

engine / hopper coupling REF. C20701.....

82



REINFORCEMENT RING

Reinforcement ring REF. C20389.....

HOPPER DRIVE SHAFT

82

80

81

83

84

83

85

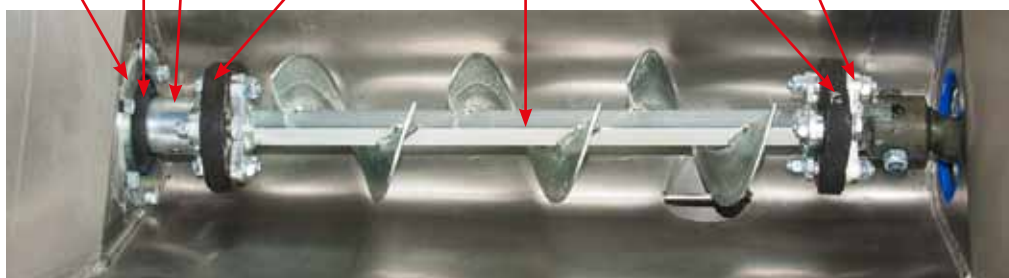

83



ELASTIC TRANSITIONAL RING

Elastic transitional ring REF. 12484.....

84

HOPPER DRIVE SHAFT

Hopper drive shaft REF. C20508.....



85



JACKET CONNECTION

Jacket connection REF. C20663

MIXER ENGINE

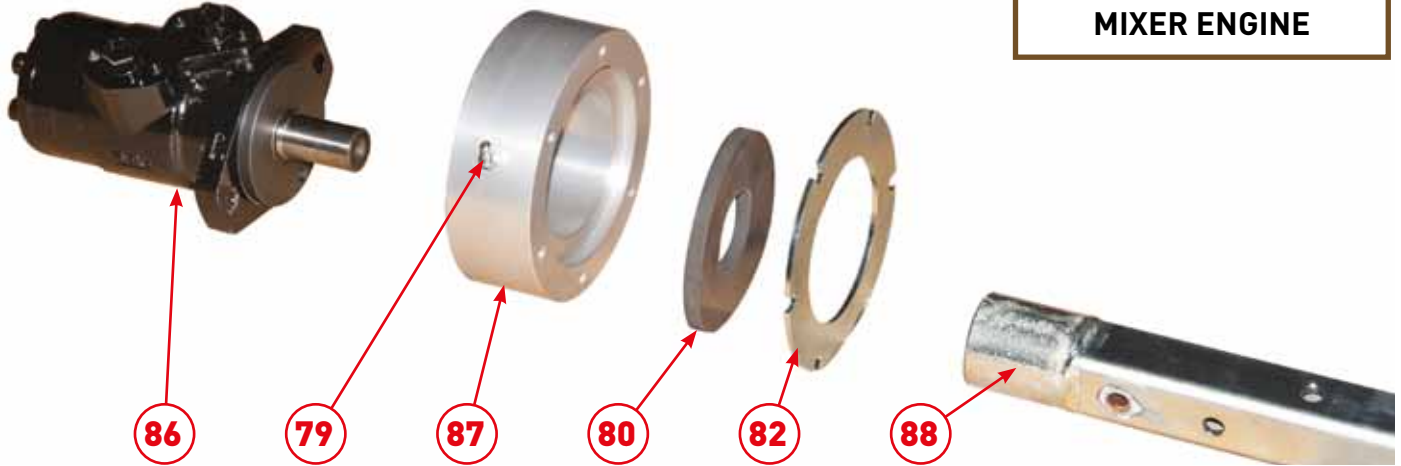

86

MIXER HYDRAULIC ENGINE

Hydraulique orbital engine for mixer BMR 250 REF. 12403

87

MIXER ENGINE BEARING

Mixer engine bearing REF. M10244

88

MIXER SHAFT

Mixer shaft REF. C20568

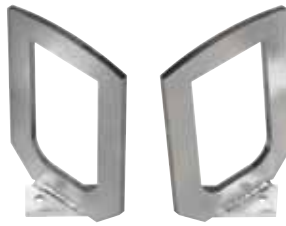

MIXING BLADES

Left mixing blade REF. C20421

Right mixing blade REF. C20422

C20421

C20422

MIXER SHAFT BEARING

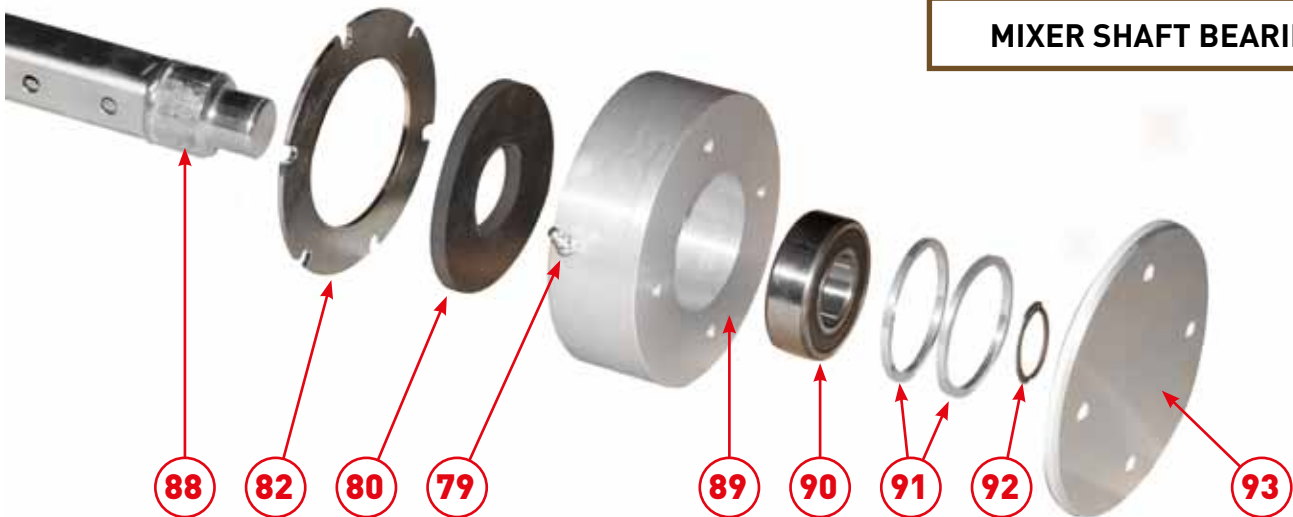

89	MIXER ROLLER BEARING Mixer roller bearing REF. M10243.....
90	MIXER SHAFT BALL-BEARING mixer shaft ball-bearing Ø35 x 72 x 23 mm REF. 12479.....
91	BALL-BEARING FITTING RING Ball-bearing fitting ring Ø 72 x 4 mm REF. M10293.....
92	CIRCLIPS External circlips Ø35 mm REF. 12481.....
93	BEARING COVER Bearing cover REF. C20510.....

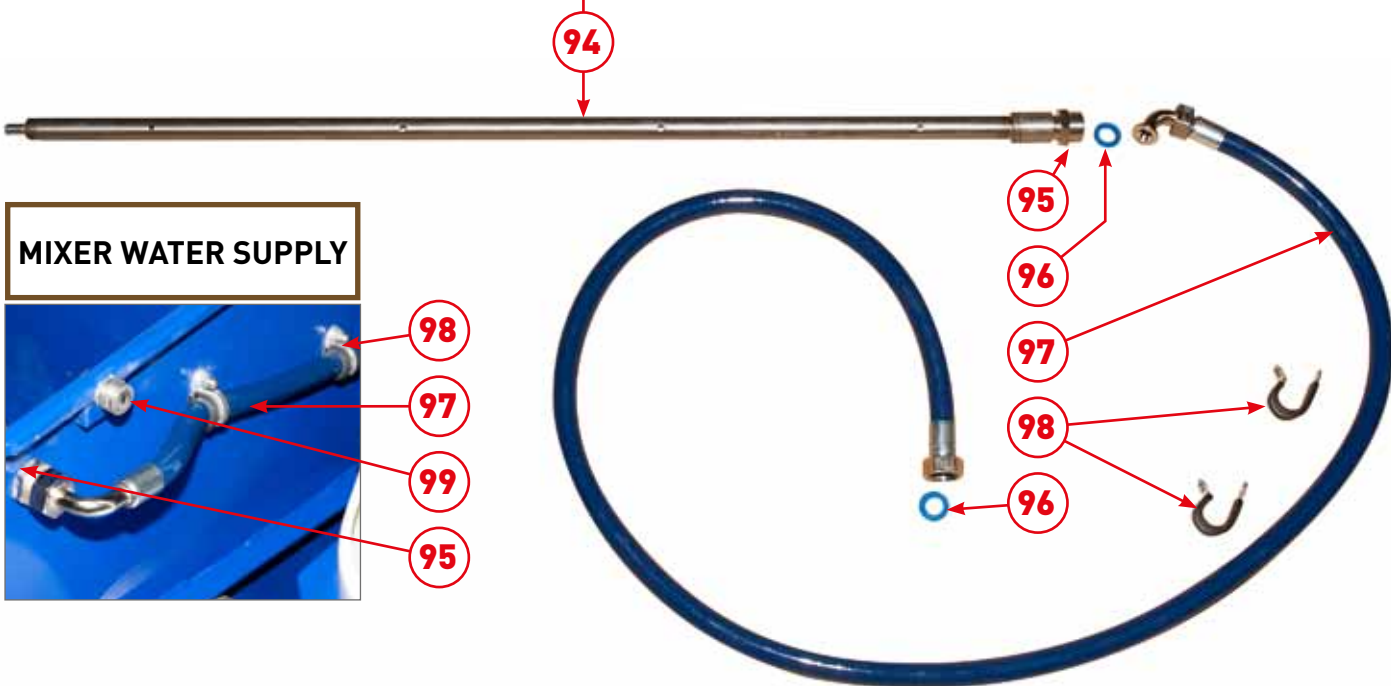
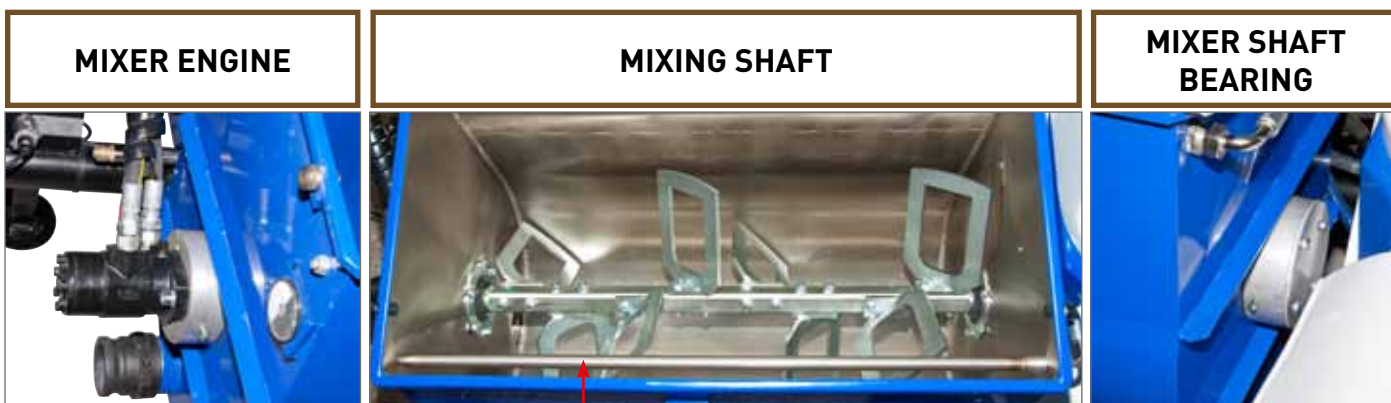

94	MIXER WATER RAMP Mixer supplying water ramp REF. C20605.....
95	LATCH LOW PRESSURE Low pressure latch 1/2 Male S x 3/4 Male S REF. 11891.....

96

PLASTIC SEAL

Plastic seal Ø20 (3/4) REF. 11618

97

WATER HOSE

Hose #123 - mixer water supply REF. 12622

98



CLAMP

clamp Ø20 mm REF. 13179

99



MIXER GRID ROLLER GUIDE

cam roller guide Ø22 with integrated lubricator REF. 13138



RUBBER STOPPER

rubber stopper Ø70 x 50 M10 REF. 12480



DRAIN PLUG

3" Female plug with cam REF. 13171

3" threaded adaptor REF. 13172



RETRO-REFLECTORS

Round and orange retro-reflector REF. 12361

Rond and white retro-reflector REF. 12362



MIXER/ HOPPER COUPLING AXIS

Coupling axis REF. C20959

Spacer ring Ø20 REF. 13209

Bearing with flange 20/23 x 16 REF. 12418

GRIDS



100 **MIXER GRID AXIS**



Mixer grid axis REF. M10409

Bearing with flange 12/14 x 15 REF. 12417

101 **MIXER GRID**

Mixer grid with anti-dust system REF. C20945

102 **HOPPER GRID**

Hopper grid REF. C20932

103 **PLASTIC PLUG**



Plastic plug Ø35 (sold per unit) REF. 80869

CONTROLS



104: LOMBARDINI control panel

105: Protection bellows for control levers

106: Bellows support flange

107: Electric beam

108: Lever bellows

109: Bellows support flange

104 **CONTROL PANEL**



LOMBARDINI control panel REF. 30537

ELECTRIC BEAM



Electric Beam for LOMBARDINI control panel REF. 30538

105 **LEVER BELLOWS**



Protection bellows for control levers REF. 13114

106 **BELLOWS SUPPORT FLANGE**



Bellows support flange REF. C20906

107



GAS HANDLE

Gas handle REF. 12386

108

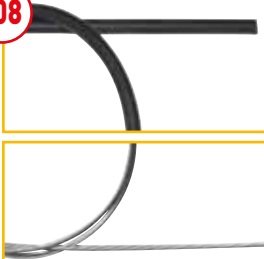

GAS HANDLE SHEATH

Sheath for gas handle steel cable Ø 8 (sold per meter)..... REF. 12388

STEEL CABLE

Steel cable for gas handle Ø 2,5 (sold per meter) REF. 12387

109



SHEATH STOPPER

Sheath stopper Ø 10 (engine side) REF. 12392

SECURITIES

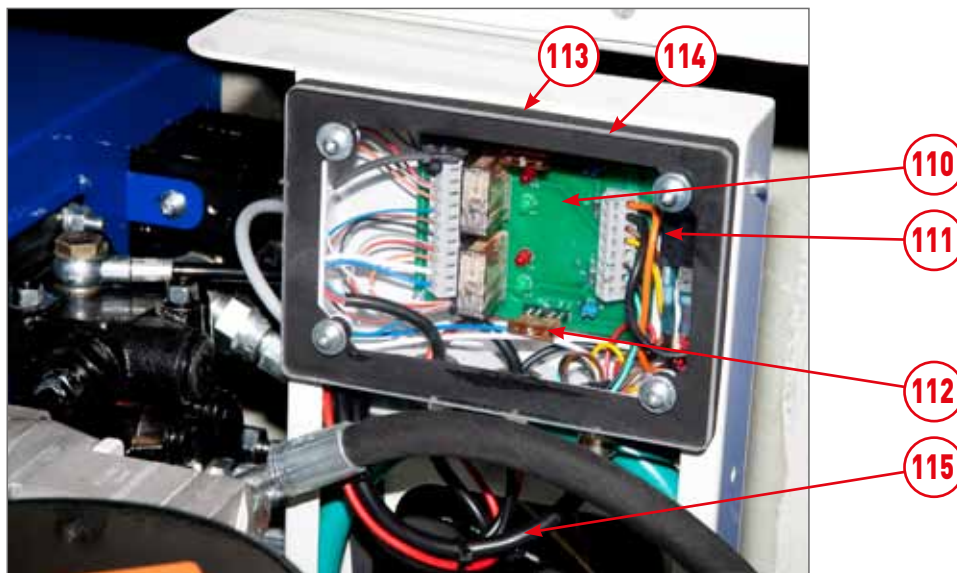

110



SECURITY ELECTRONIC CARD

Security electronic card REF. 12988

111



ELECTRICAL RELAY

Electrical relay 12V in C REF. 13108

112



US FUSES

US fuse standard 2A REF. 13079
US fuse standard 5A REF. 13080

113 **ELECTRIC BOX SEAL**
 Electrical box seal REF. 13018



114 **ELECTRIC BOX DOOR**
 Electric box door REF. 13017



115 **ELECTRIC BEAM**
 Electric beam for security card supply REF. 13204



CABLE GLANDS
 Nickel plated cable gland M 16 REF. 80445
 Nickel plated cable gland M 20 REF. 80448



CABLE GLAND NUT
 Cable gland nut M16 REF. 11327



**SÉCURITÉS
GRILLES**

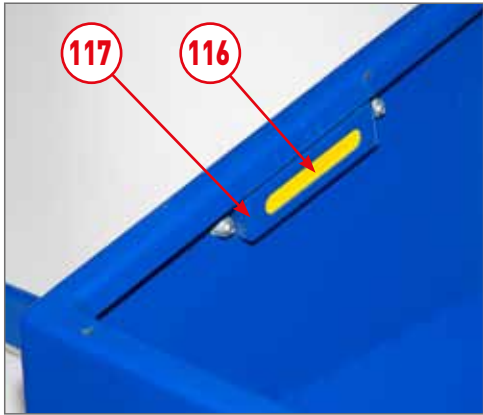
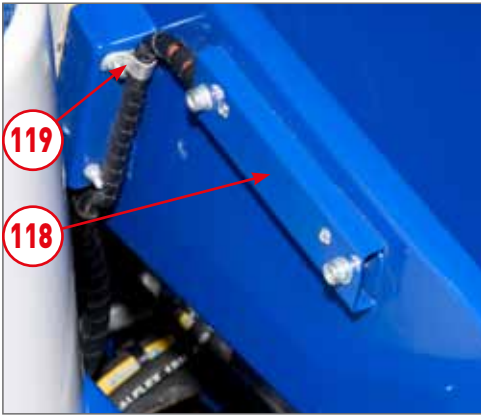

116 **SECURITY GRID CAPTOR**
 Security grid captor - cat. 3 autonomous 12Vcc REF. 12980



117 **CAPTOR INTERNAL SUPPORT**
 Captor internal support REF. C20871



118 **CAPTOR EXTERNAL SUPPORT**
 Captor external support REF. C20869



119 **WIRE-PASS CLIP**
 Wire-pass clip Ø 7,9 REF. 90266



EMERGENCY STOP

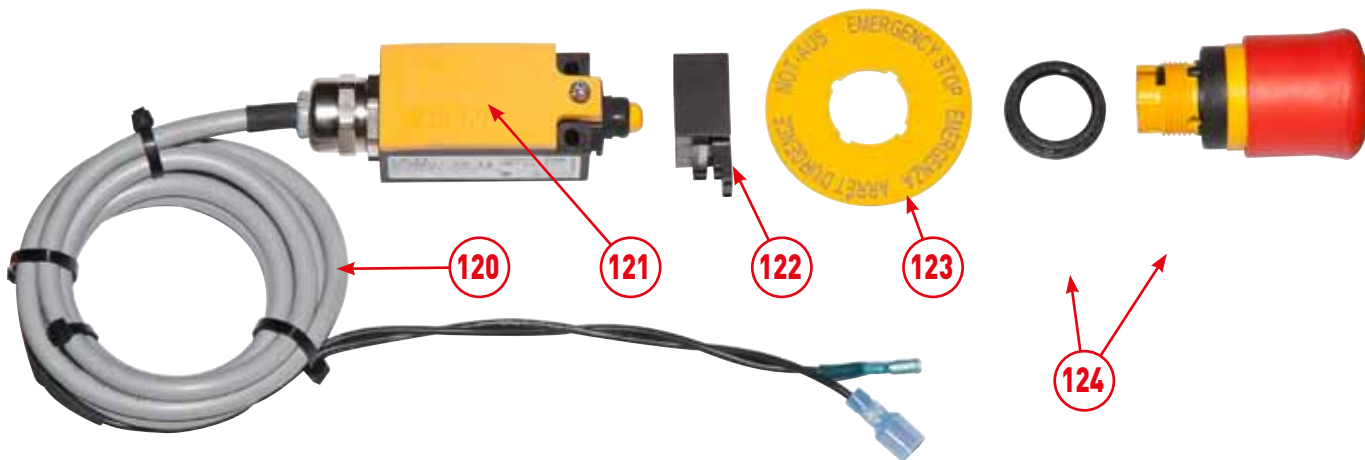

120

ELECTRIC CABLE

Electric cable H05VV5F 2 x 1 mm² REF. 11973

121

SECURITY CONTACT

Push security contact REF. 12663

122

ADAPTOR

Contact security / Emergency Stop button adaptor REF. 12664

123

"EMERGENCY STOP" LABEL

Round "Emergency Stop" label REF. 12824

124

"EMERGENCY STOP" BUTTON

"Emergency Stop" push button REF. 90727

HOOD & COUPLING



125

BIG MOBIL HOOD

big mobil hood REF.
12798

126

SMALL SETTLED HOOD

Small settled hood REF. 12799

127



HOOD HINGE

hood hinge REF. 12797

128



INSPECTION DOOR

Inspection door REF. C20986



PLASTIC HANDWHEEL

Plastic handwheel M5 x 20 REF. 12396

129



HOOD LOCK

Hood stainless steel lock REF. 13111



RUBBER STOP

Hood rubber stop REF. 12385

HOOD GAZ SPRING

Hood gas spring REF. 80209



HOOD ANGLE REINFORCEMENT

Hood angle reinforcement REF. C20866



130



ANCHORING RINGS

Rings to anchor the machine to the ground REF. C20976

131

RETRECTABLE FOOTSTAND

Retractable footstand REF. 13106



JOCKEY WHEEL OPTIONAL

Jockey wheel REF. 12367

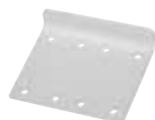

JOCKEY WHEEL PLATE OPTIONAL

Jockey wheel plate REF. C20368

132  **BEAM**
Beam TZ 750 kg SF 150R REF. 12350

133  **COUPLING TOWBAR**
Coupling towbar Ø50 - TZ system REF. 12877

 **COUPLING RING**
coupling ring 48 x 68 - TZ system REF. 12876

134  **SAFETY CHAIN**
Complete safety chain REF. 12886

135  **CLAMPING LEVER**
Complete clamping lever Ø20 REF. 12983

 **STATOR CENTRING RING**
Stator centring ring REF. M10361

 **MOUNTING BRACKETS**
Short mounting bracket for pump REF. M10354
Long mounting bracket for pump REF. M10281

 **PUMP NOZZLE**
Threaded pump nozzle 1 1/4 REF. C20985

 **TAPPED ADAPTOR**
Tapped adaptor 1 1/4" REF. 70011

 **STATOR**
Stator for pump CP60, 36-35 grey REF. 13037

 **ROTORS**
Rotor 36-35 with pierced slotted head REF. 13038

 **ROTOR HEAD SCREW**
Rotor head screw REF. 12497

HOSES

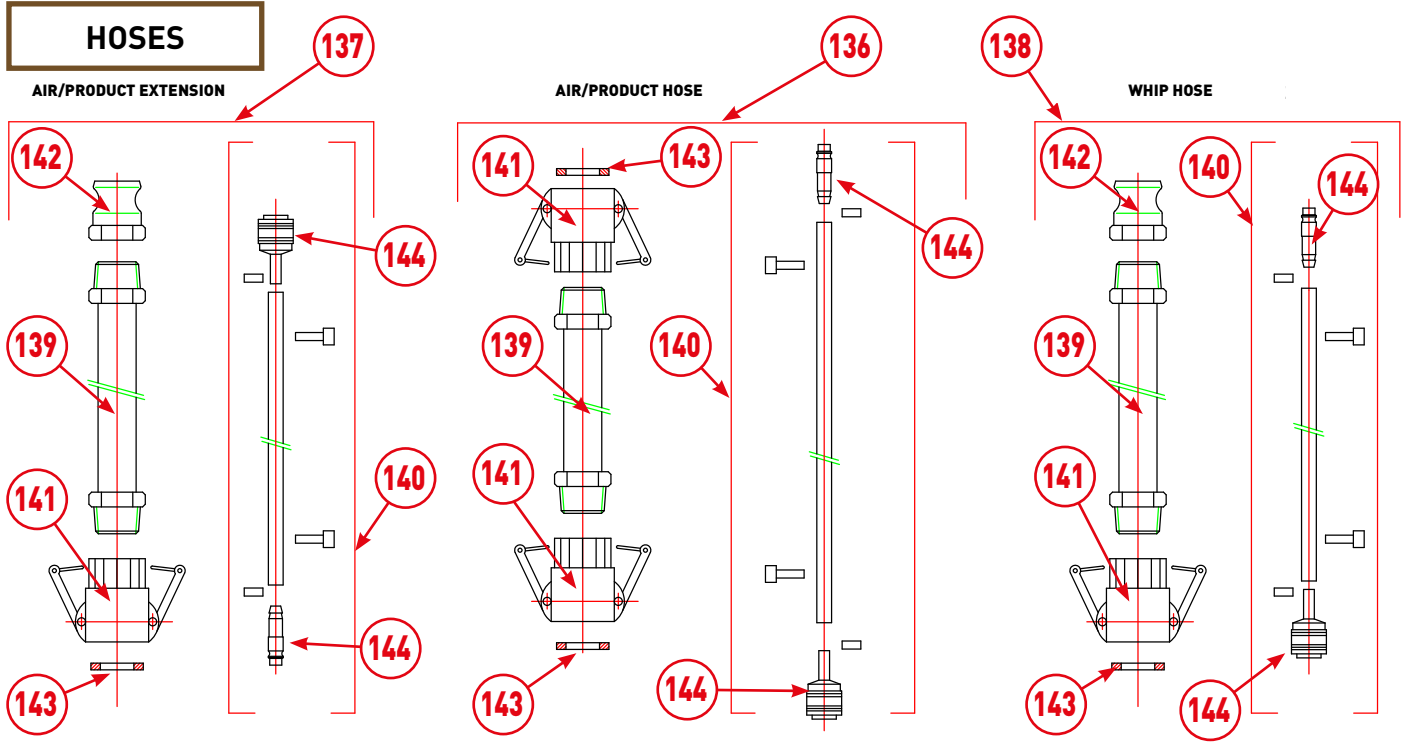

136

COMPLETE AIR-PRODUCT HOSES



Air-product hose Ø 32 x 10 m complet	REF. 30143
Air-product hose Ø 32 x 15 m complet	REF. 90542
Air-product hose Ø 32 x 20 m complet	REF. 30144

137

COMPLETE AIR-PRODUCT EXTENSIONS



Air-product extension Ø 35 x 10 m complète	REF. 12039
Air-product extension Ø 35 x 15 m complète	REF. 12170
Air-product extension Ø 35 x 20 m complète	REF. 12077

138

AIR-PRODUCT WHIP EXTENSIONS



Air-product whip extension Ø 25 x 5 m complète	REF. 50049
--	------------

139

PRODUCT HOSES



Threaded product hose Ø 25 x 5m - 1" without connector	REF. 50010
Threaded product hose Ø 32 x 10 m - 1" 1/4 x 1" without connector	REF. 50015
Threaded product hose Ø 32 x 15 m - 1" 1/4 x 1" without connector	REF. 50009
Threaded product hose Ø 32 x 20 m - 1" 1/4 x 1" without connector	REF. 12998
Threaded product hose Ø 35 x 10 m - 1" 1/4 without connector	REF. 11977
Threaded product hose Ø 35 x 15 m - 1" 1/4 without connector	REF. 11978
Threaded product hose Ø 35 x 20 m - 1" 1/4 without connector	REF. 11979

140

COMPLETE AIR HOSES WITH CONNECTORS



Complete air hose 5,25 m	REF. 91062
Complete air hose 10,85 m	REF. 91064
Complete air hose 15,85 m	REF. 13203
Complete air hose 20,85 m	REF. 12486

141  **TAPPED CAM COUPLER**

1" tapped cam coupler (lance side)	REF. 70007.....
1" 1/4" tapped cam coupler (pump side)	REF. 70006.....

142  **TAPPED ADAPTOR**

1" tapped adaptor	REF. 70002.....
1" 1/4" tappad adaptor	REF. 70012.....

143  **CAM COUPLER SEAL**

1" cam coupleur seal (lance side)	REF. 70014.....
1" cam coupleur seal (pump side)	REF. 70015.....

144  **FEMALE QUICK CONNECTOR WITH A FLUTED SHANK**

Female quick connector with a fluted shank 9 mm	REF. 70004.....
---	-----------------

145  **MALE QUICK CONNECTOR**

Male quick connector with a fluted shank 9 mm	REF. 70018.....
---	-----------------

 **AIR HOSE PER METER**

Armed chrystal air hose per meter Ø10x16	REF. 50003.....
--	-----------------

 **CAM LOCKS**

Cam lock 1"	REF. 90689.....
Cam lock 1" 1/4"	REF. 90691.....

 **CLAMP**

Clamp with screw 13 x 20 x 9	REF. 60002.....
Spring clamp Ø15	REF. 12218.....

 **RILSAN CLAMP**

Rilsan clamp 9 x 262	REF. 30048.....
----------------------------	-----------------

 **OILS**

Compressor oil	REF. 80043.....
Diesel 4 cycle engine oil	REF. 30390.....
Hydraulic oil	REF. 12343.....

 **COOLING FLUID**

Cooling fluids	REF. 80189.....
----------------------	-----------------

 **CLEANING BALLS**

Small diameter cleaning ball	REF. 20005.....
Big diameter cleaning ball	REF. 90566.....